



M687

CONT 625 kVA



THREE-PHASE SYNCHRONOUS GENERATOR

Datasheet for 4 poles -50Hz @ 1500rpm/ 60Hz @ 1800rpm

Ambient Temperature	40 °C	Method of Cooling	Air cooling	
Temperature Rise	125 °C	Direction of Rotation	Clockwise	
Insulation Class	H	Maximum Over-speed	2250r/min	
Power Factor	0.8	Degree of Protection / Enclosure	IP23	
Excitation	Brushless	Altitude	1000m	
Winding Pitch	2/3	Stator winding	DLL	
Pole	4	Number of Terminal	12	
Duty	S1- Continuous	Rotor	With damping cage	
Waveform	TIF<50		THF<2%	
Waveform distortion	BS EN 61000-6-2&BS EN 61000-6-4,VDE 0875G,VDE0874N			
Radio interference	Noload<1.5%,Non-distorting balanced linear load<5%			
AVR MODEL AVR	Standard	Selection		PMG
	AS440	KRS440		MX341B MX321
Voltage Regulation - in steady state condition	±1.0	±1.0	±0.5	±0.5
Short Circuit Current Capacity	Control does not sustain a short circuit current			2900A

Electrical Characteristic

Frequency	Hz	50				60			
Voltage (series star) Y	V	380/220	400/231	415/240	440/254	416/240	440/254	460/266	480/277
Voltage (parallel star) YY	V	190/110	200/115	208/120	220/127	208/120	220/127	230/133	240/138
Voltage (series delta) Δ	V	220	230	240	254	240	254	266	277
Rated power at Class H (125 °C) temperature rise	kVA	625	625	625	605	690	720	740	750
	kW	500.0	500.0	500.0	484.0	552.0	576.0	592.0	600.0
Efficiency at Class H (P.F.=0.8)	4/4%	94.8	95	95	95.2	95	95	95	95.1
	3/4%	95.4	95.5	95.5	95.5	95.4	95.4	95.5	95.5
	2/4%	95.5	95.3	95.3	95.1	95.2	95.2	95.2	95.2
Efficiency at Class H (P.F.=1.0)	4/4%	95.9	96.1	96.1	96.2	96	96	96.1	96.1
	3/4%	96.4	96.5	96.6	96.5	96.4	96.5	96.5	96.5
	2/4%	96.5	96.4	96.3	96.2	96.2	96.2	96.2	96.2

Reactances (%) at Class H

Direct axis synchronous reactance unsaturated	X _d	2.9	2.62	2.43	2.1	3.33	3.13	2.95	2.8
Direct axis transient reactance saturated	X' _d	0.16	0.14	0.13	0.11	0.16	0.15	0.14	0.13
Direct axis subtransient reactance saturated	X'' _d	0.11	0.1	0.09	0.08	0.11	0.1	0.1	0.09
Quadrature axis synchronous reactance unsaturated	X _q	2.42	2.19	2.03	1.75	2.66	2.5	2.36	2.23
Quadrature axis subtransient reactance saturated	X'' _q	0.25	0.23	0.21	0.18	0.31	0.29	0.27	0.26
Leakage reactance	X _l	0.05	0.04	0.04	0.03	0.05	0.05	0.04	0.04
Negative sequence reactance saturated	X ₂	0.18	0.16	0.15	0.13	0.21	0.2	0.19	0.18
Zero sequence reactance unsaturated	X ₀	0.08	0.08	0.07	0.06	0.09	0.08	0.08	0.08
Short-circuit ratio	K _{cc}	0.3448	0.3817	0.4115	0.4762	0.3003	0.3195	0.3390	0.3571

Short-circuit transient time constant (sec.)	T' _d	0.08							
Subtransient time constant (sec.)	T'' _d	0.012							
Open circuit time constant (sec.)	T' _{do}	2.5							
Armature time constant (sec.)	T _a	0.019							
Stator Winding Resistance (20°C)	ohm	0.0034							
Rotor Winding Resistance (20°C)	ohm	2.14							
Exciter Stator Resistance (20°C)	ohm	17							
Exciter Rotor Phase resistance	ohm	0.092							
No load excitation current	i _o (A)	0.59	0.6	0.63	0.64	0.59	0.6	0.61	0.64
Full load excitation current	i _c (A)	2.4	2.4	2.5	2.5	2.4	2.4	2.5	2.5
Cooling air requirement	m ³ /sec	1.035m ³ /s 2202cfm				1.312m ³ /s 2780cfm			

Mechanical Characteristic

Configuration	Single Bearing	Double Bearing
Type of Construction	B2-SAE	IM B34
Total Weight - kgs	1580	1560
Weight wound stator - kgs	745	745
Weight wound rotor - kgs	684	655
Inertia (J) [kgm ²]	10.033kgm ²	9.7551kgm ²
Drive end bearing / Lubrication		BALL.6220-2RS(ISO)
Non-drive end bearing / Lubrication	BALL.6314-2RS(ISO)	BALL.6314-2RS(ISO)
Packing crate size (cm)	149X80X115	156X80X115

Winding 311 0.8 Power Factor

RATINGS

Class - Temp Rise		Cont. F - 105/40° C				Cont. H - 125/40° C				Standby - 150/40° C				Standby - 163/27° C			
50 Hz	Series Star (V)	380	400	415	440	380	400	415	440	380	400	415	440	380	400	415	440
	Parallel Star (V)	190	200	208	220	190	200	208	220	190	200	208	220	190	200	208	220
	Series Delta (V)	220	230	240	254	220	230	240	254	220	230	240	254	220	230	240	254
	kVA	575	575	575	556.6	625	625	625	605	675	675	675	653.4	693.75	693.8	693.8	671.6
	kW	460	460	460	445.3	500	500	500	484	540	540	540	522.7	555	555	555	537.2
	Efficiency (%)	95	95.2	95.3	95.4	94.8	95	95.1	95.3	94.6	94.8	94.9	95.1	94.4	94.6	94.8	95.1
	kW Input	484	483	483	467	527	526	526	508	571	570	569	550	588	587	585	565
60 Hz	Series Star (V)	416	440	460	480	416	440	460	480	416	440	460	480	416	440	460	480
	Parallel Star (V)	208	220	230	240	208	220	230	240	208	220	230	240	208	220	230	240
	Series Delta (V)	240	254	266	277	240	254	266	277	240	254	266	277	240	254	266	277
	kVA	644	676.2	676.2	702	700	735	735	763	742	771.75	771.8	808.8	770	808.5	808.5	839.3
	kW	515.2	541	541	561.6	560	588	588	610.4	593.6	617.4	617.4	647	616	646.8	646.8	671.4
	Efficiency (%)	95.1	95.2	95.3	95.3	95	95	95.1	95.1	94.8	94.9	94.9	95	94.7	94.8	94.8	94.9
	kW Input	542	568	568	589	589	619	618	642	626	651	651	681	650	682	682	708

DIMENSIONS

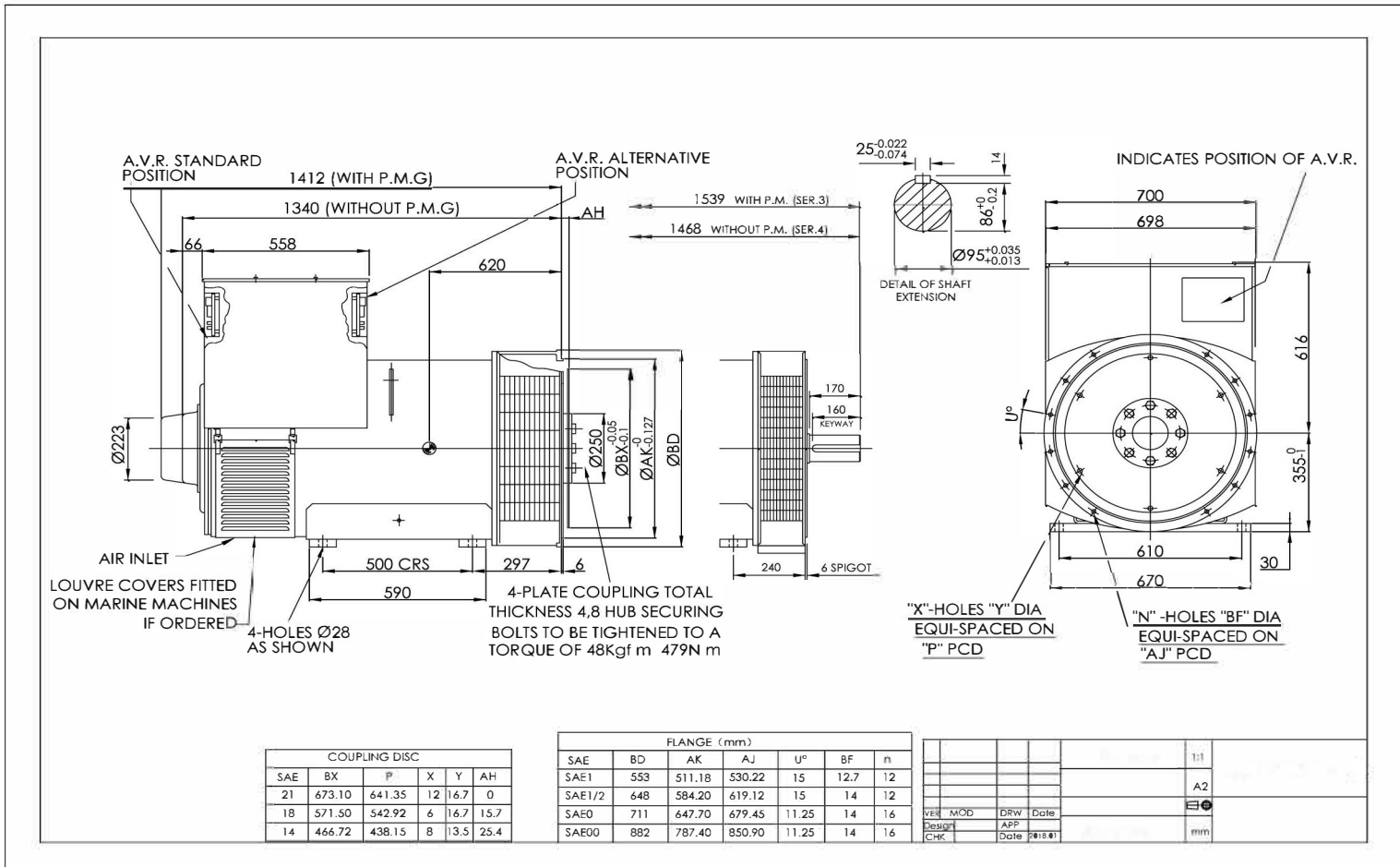

**50
Hz**

Winding 311

THREE PHASE EFFICIENCY CURVES

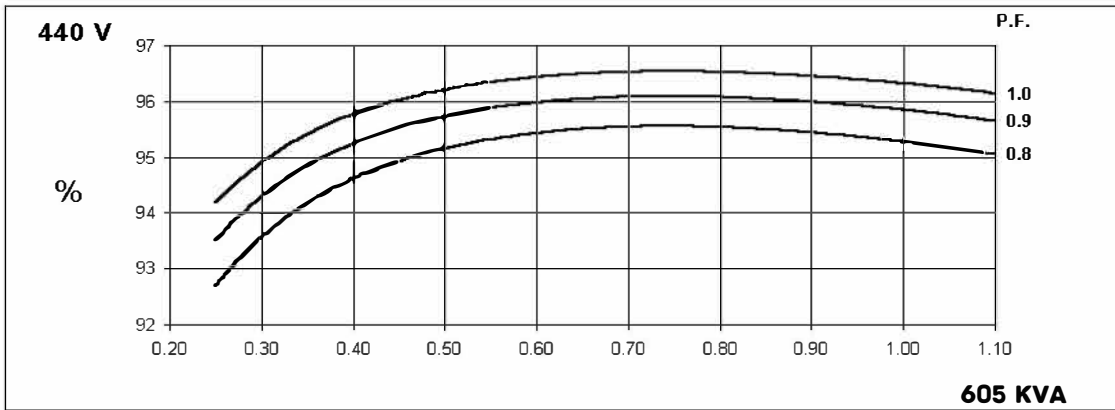
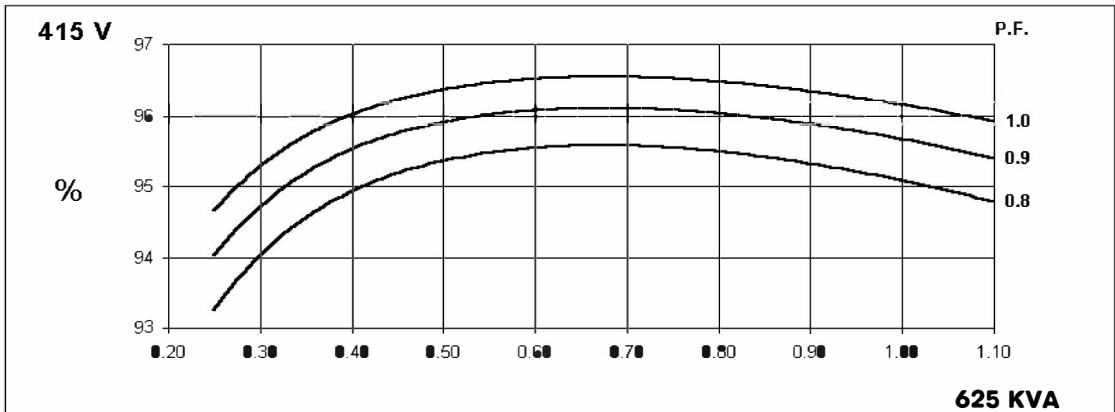
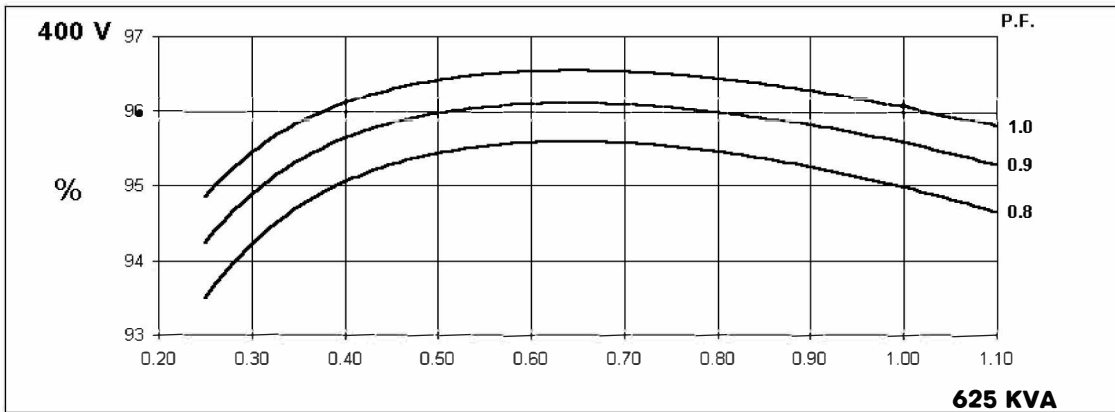
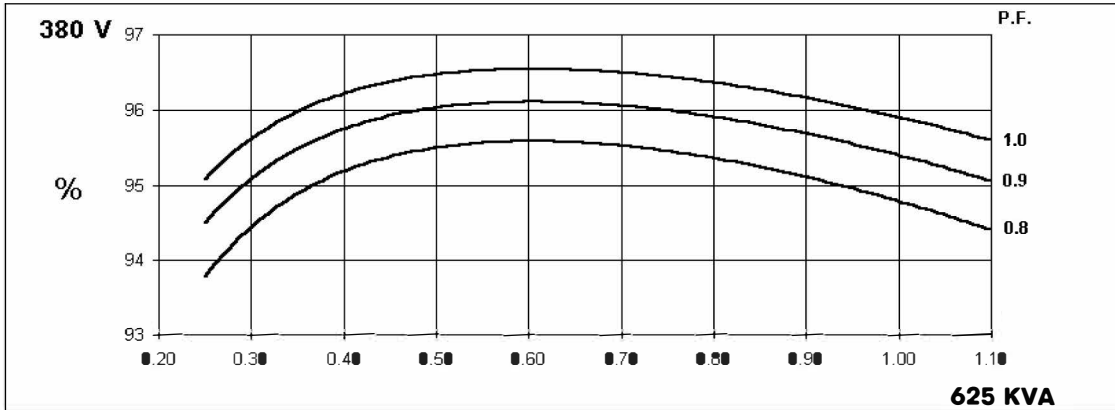

**60
Hz**

Winding 311

THREE PHASE EFFICIENCY CURVES

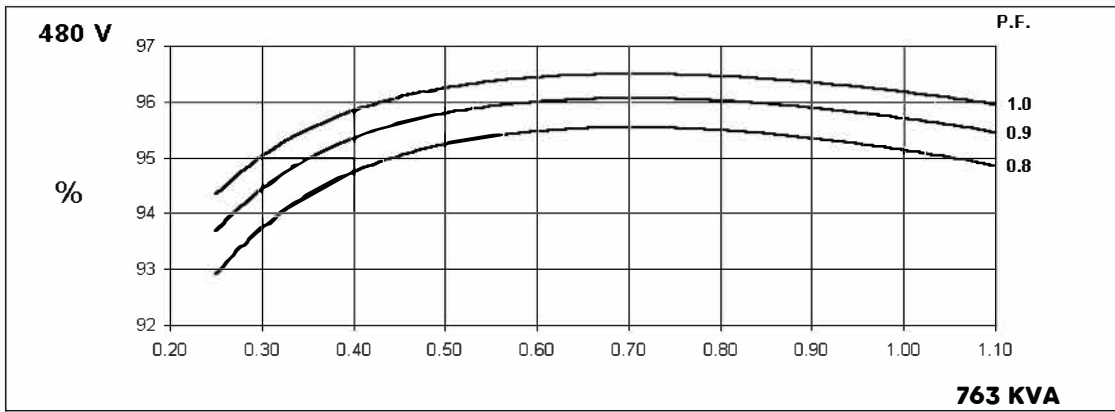
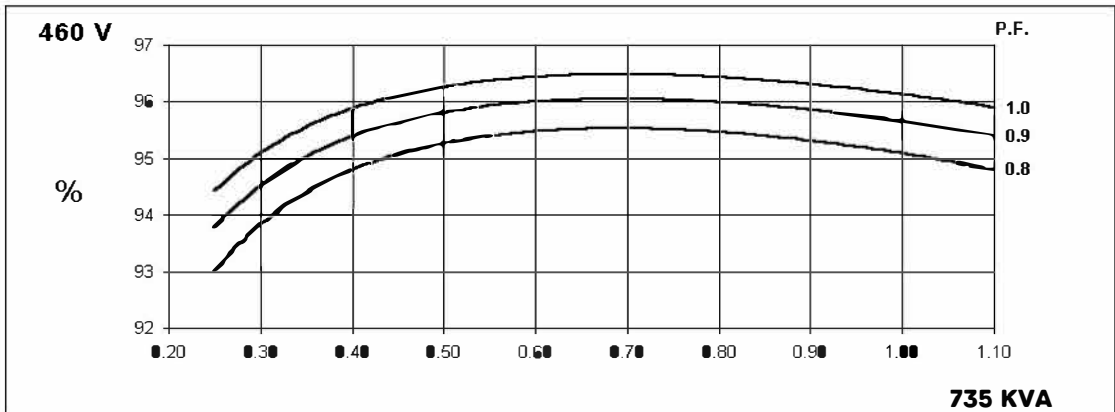
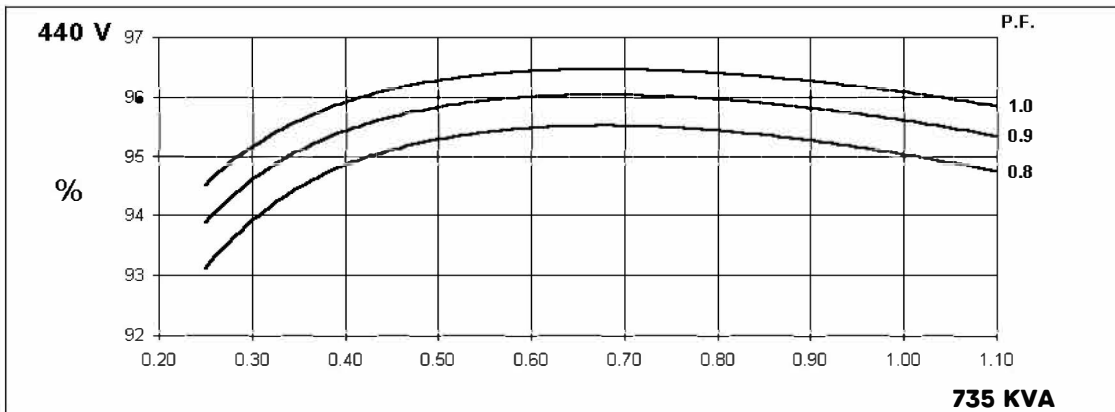
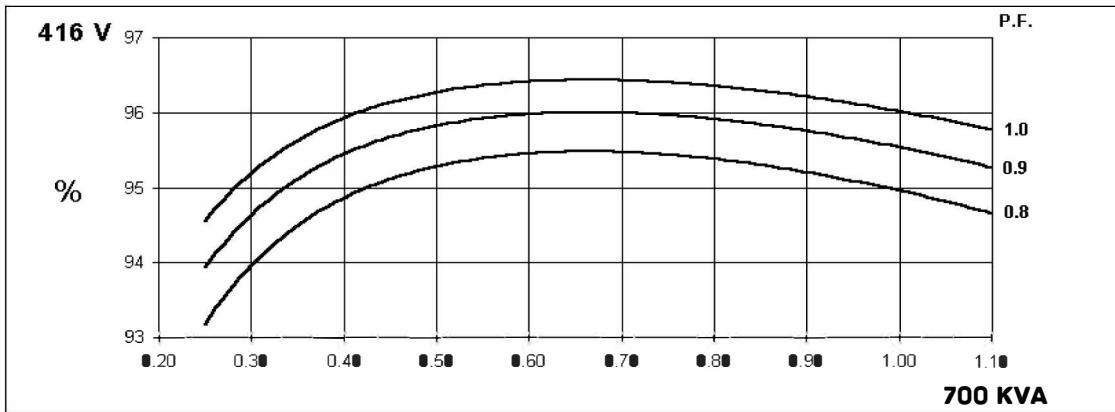

Three-phase Short Circuit Decrement Curve. No-load Excitation at Rated Speed Based on star (wye) connection.

50
Hz

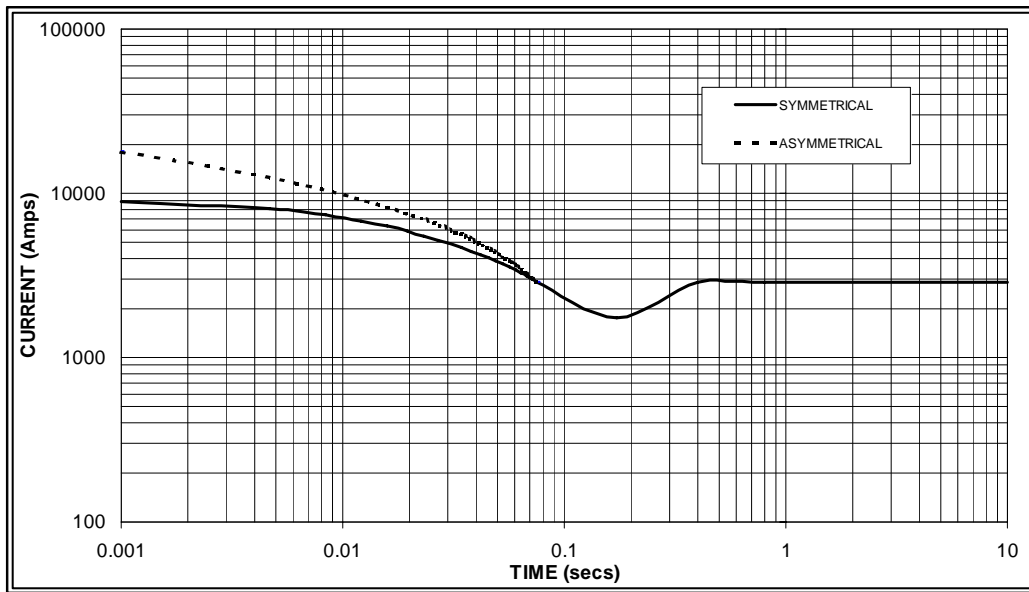

Sustained Short Circuit = 2,900 Amps

60
Hz

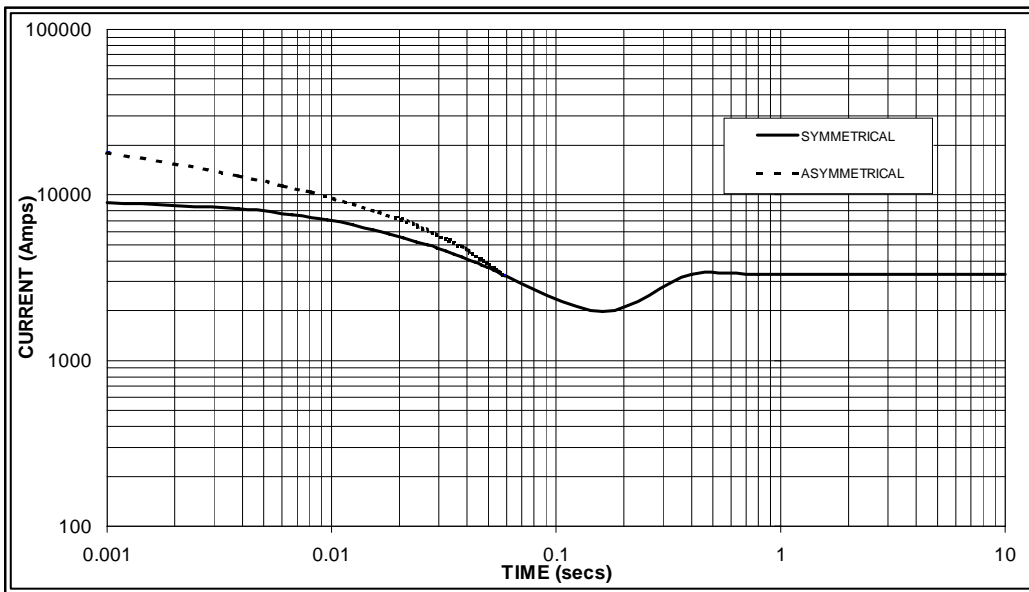

Sustained Short Circuit = 3,300 Amps

Note 1

The following multiplication factors should be used to adjust the values from curve between time 0.001 seconds and the minimum current point in respect of nominal operating voltage :

50Hz		60Hz	
Voltage	Factor	Voltage	Factor
380v	X 1.00	416v	X 1.00
400v	X 1.06	440v	X 1.06
415v	X 1.09	460v	X 1.12
440v	X 1.12	480v	X 1.20

The sustained current value is constant irrespective of voltage level

Note 2

The following multiplication factor should be used to convert the values calculated in accordance with NOTE 1 to those applicable to the various types of short circuit :

	3-phase	2-phase L-L	1-phase L-N
Instantaneous	x 1.00	x 0.87	x 1.30
Minimum	x 1.00	x 1.80	x 3.20
Sustained	x 1.00	x 1.50	x 2.50
Max. sustained duration	10 sec.	5 sec.	2 sec.

All other times are unchanged

Note 3

Curves are drawn for Star (Wye) connected machines. For other connections the following multipliers should be applied to current values as shown :

Parallel Star = Curve current value X 2

Series Delta = Curve current value X 1.732

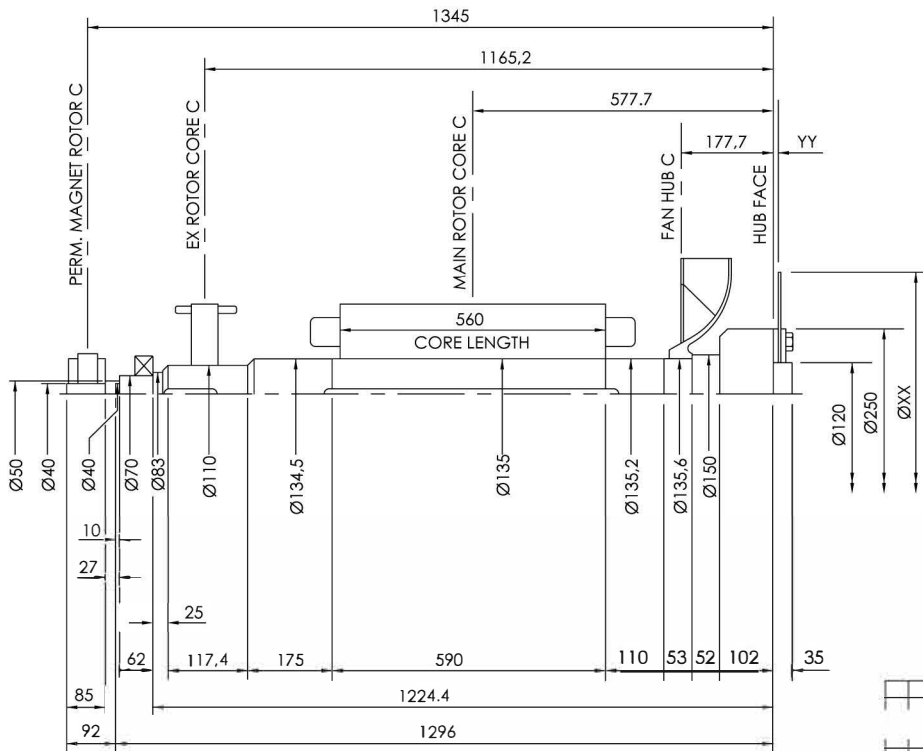

COMPONENT	Wt kg	J kgm ²
EX. ROTOR	31,290	0,5100
MAIN ROTOR	470	8.56
FAN	12.53	0,393
SHAFT	138.092	0,3062
HUB	23.922	0,2455
TOTAL	675.834	10.0147
PERM. MAG.	7.899	0,0183
TOTAL	683.733	10.033

COUPLING SAE No	COUPLING DIMEN's		COUPLING ASSEMBLY WEIGHT kg	COUPLING DISC J kgm ²
	XX	YY		
11,5	352	23,8	12,08	0,055
14	467	9,5	11,66	0,172
18	572	0,0	12,07	0,386

VER	MOD	DRW	Date
Design		APP	
CHK		Date	2018.01

mm

