

GENERATOR SETS

Standby	kVA	40
	kW	37,5
Prime	kVA	32
	kW	30
Rpm	[r/min]	1500
Voltage Options	V	400
Frequency		50
Power Factor		0,8
Electrical Efficiency	%	≥38
Thermal Efficiency	%	≥48.1
Total Efficiency	%	≥86..1
Gas Consumption	m ³ /h	8,7

CERTIFICATES

- ◆ CE Certificate
 - ◆ 2006/42/EC Machinery Safety Directive
 - ◆ 2014/30/EU Electromagnetic Compatibility Directive
 - ◆ 2014/35/EU Low Voltage Directive
 - ◆ 2000/14/EC By Equipment Used in the Open Field
 - ◆ Regulation on Noise Emission in the Created Environment
 - ◆ EN 12100:2010, TS EN 60201-1, EN 55011, EN 61000-6-4, EN 61000-4-11, EN 61000-4-8, EN 61000-4-5, EN 61000-4-2, EN 61000-4-2, EN 12601, TS ISO 8528-1-12
- ◆ TSE Certificate of Conformity to Turkish Standards
 - ◆ TS EN 60034-1:2010
 - ◆ TS ISO 8528-5
 - ◆ TS ISO 8528-4
 - ◆ TSE Service Place Qualification Certificate
- ◆ ISO 9001:2015 Quality Management System Certificate
- ◆ ISO 14001:2015 Environmental Management System Certificate
- ◆ OHSAS 18001:2007 Occupational Health and Safety Management
- ◆ ISO 10002:2014 Customer Satisfaction Management. System Cer.
- ◆ TS ISO/IEC 25051:2015 Software Engineering Certificate
- ◆ Republic of Turkey Ministry of Trade, After Sales Services
- ◆ 1500 hl Salt Water Test Certificate TS EN ISO/IEC 17025
- ◆ Manufacturing Competence Certificate
- ◆ Industrial Registry Certificate
- ◆ Capacity Report
- ◆ Trademark Registration Certificate
- ◆ EAC Certificate / Gost-R Certificate
- ◆ Yuchai OEM Manufacturer Certificate



ENGINE

Engine Brand		Yuchai
Engine Model		YC4D55N-D30
Rated Power	<i>kW</i>	37
Number of Cylinders		4
Form		Four stroke
Cylinder Arrangement		Inline
Cooling System		Water Cooling
Bore x Stroke	<i>mm</i>	108x115
Displacement	<i>L</i>	4,21
Control system		ECU
Oil consumption rate	<i>g/kWh</i>	≤0.2
Coolant capacity (including radiator)	<i>L</i>	32
Oil capacity	<i>L</i>	13
Overhaul interval	<i>h</i>	40000

ALTERNATOR OPTIONS

Standart	Evotech
Option - 1	Engga
Option - 2	Leroy Somer
Option - 3	Stamford
Option - 4	Mecc Alte

ENGINE

G-Drive Series heavy duty Natural Gas engine
4 cycle, water cooled, turbocharged / turbocharged & air to air charge cooled
Direct injection and Spark Ignition System
Electronic governor system
24 volt self-starter / Air Starter System
Tropical type Fix, Table or V Type radiator
Gas Train Equipment
Oil discharge valve and extension pipe
Industrial type silencer, exhaust spiral or compensator
Maintenance free battery
Engine Management System
Maintenance and operating instructions
Low emission standard, lean burn technology resulting in lower NOx emissions
High transient and block load capabilities
Full duty cycle capability, from prime to continuous power
Electronically controlled high efficiency engines

ALTERNATOR

Brushless, single or two bearing
H or F Class Continuous Operation type
IP21-23 Protection or higher Class
Self exciter
Automatic voltage regulator
Medium Voltage Output Level 3,3 kV 6,3 kV 11 kV and 15 kV
2/3 Pitch factor windings
4 Poles, 6 Poles, 8 Poles or 12 Poles

OPTIONAL EQUIPMENTS

Charge ampmeter
Circuit breakers or Medium Voltage Panels
Residential / Critical type silencer and Chimney
Sound-proof Container or Building Installation
Synchronization panel for 2-32 gensets
Scada and Monitoring Systems
Fuel and oil heater
Anticondensation heater
Fuel automation systems
PMG

HEAT BALANCE PARAMETERS

Coolant heat of cylinder liner (±8%)	kW	65
Coolant heat of oil cooler (±8%)	kW	14
Total coolant heat of high temperature cooling system (± 8%)	kW	79
Coolant heat of intercooler (±8%)	kW	18
Total coolant heat of low temperature cooling system (± 8)	kW	18
Waste heat of exhaust gas (with the exhaust gas temperature up to 120°C) (±8%)	kW	56
Total radiant heat (±8%)	kW	10

COOLING PARAMETERS

Flow rate of high temperature circulating water	m ³ /h	3
Inlet temperature of high temperature circulating water (± 2%)	°C	81,7
Outlet temperature of high temperature circulating water (± 2%)	°C	88
Low temperature inlet water temperature (±2%)	°C	50
Low temperature outlet water temperature (±2%)	°C	52,2

INTAKE AND EXHAUST PARAMETERS

Air intake	kg/h	477,3
Gas intake	kg/h	18,4
Air displacement	kg/h	495,7
Exhaust temperature after turbocharger (±5%)	°C	510

TEST CONDITIONS

Calorific value of gas	kWh/m	9,1
Volume content of methane	%	≥96
Gas temperature	°C	-10~40°C
Gas intake pressure□ Before regulator□	kPa	800□1000
Gas intake pressure□ After regulator□	kPa	400□600
Air intake negative pressure	kPa	>-3
Exhaust back pressure	kPa	<5
Absolute atmospheric pressure	kPa	101,32
Ambient temperature	°C	25
Relative humidity	%	30
Altitude	m	≤1,000

DIMENSIONS

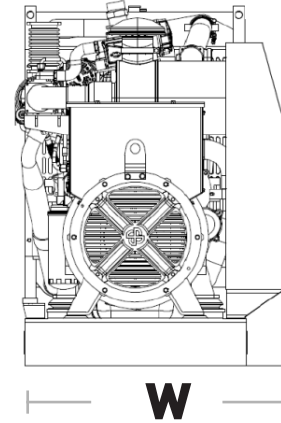
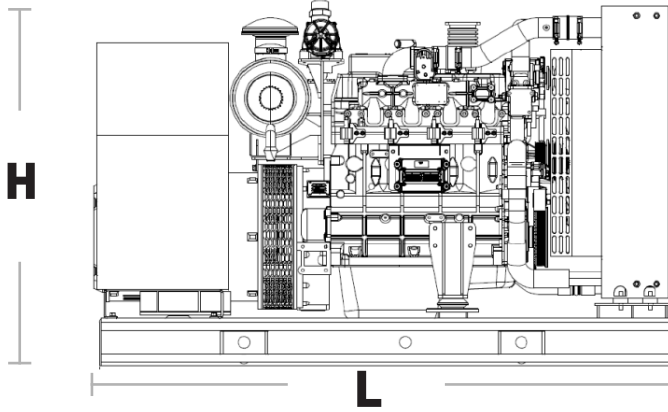

WITHOUT CABIN

Length (L) x Width (W) x Height (H)	mm	1900x720x920
Weight	kg	1000

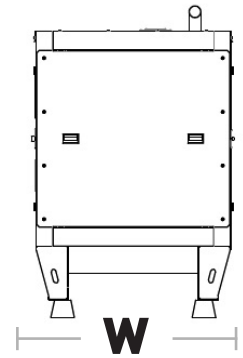
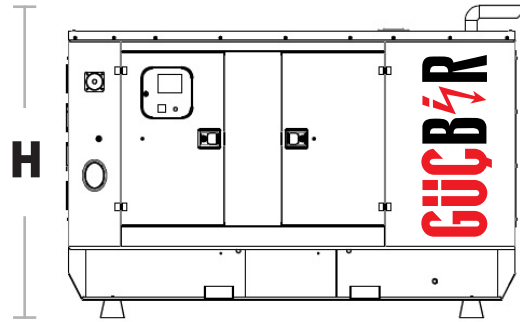
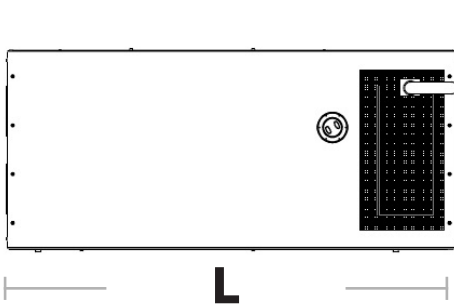

WITH CANOPY CONTAINER

Length (L) x Width (W) x Height (H)	mm	2440x1000x1860
Weight	kg	1400

SOUND ISOLATION CABINET FEATURES

- ◆ Container and modular cabin production
- ◆ 65-75db. sound insulation
- ◆ Anti-vibration system
- ◆ Grilles for cooling and air circulation
- ◆ Special attachments for easy transportation
- ◆ Insulated transparent cover for easy access to the control cabinet
- ◆ Hidden exhaust
- ◆ Emergency stop button

CONTROL PANEL

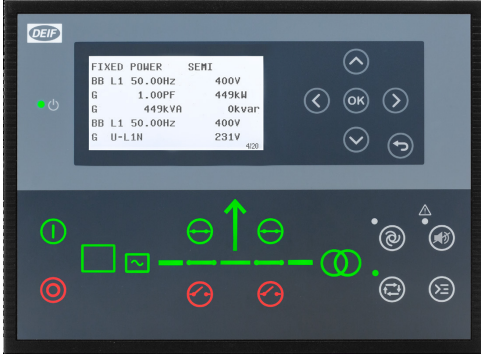

CONTROL UNIT



- ◆ The AGC 150 is an easy-to-use control unit containing all necessary functions for protection and control of a genset.
- ◆ It can be used as a single unit for one genset, or it can be connected in a complete power management system with up to 32 controllers for synchronising projects, island or parallel to the mains. The power management system handles the load sharing between gensets and the load-dependent start and stop.
- ◆ AGC 150 contains all necessary 3-phase measuring circuits, and all values and alarms are presented on the sun proof LCD display.

SWITCHGEAR

Specially prepared according to needs Air Insulated Metal Enclosed Switchgears

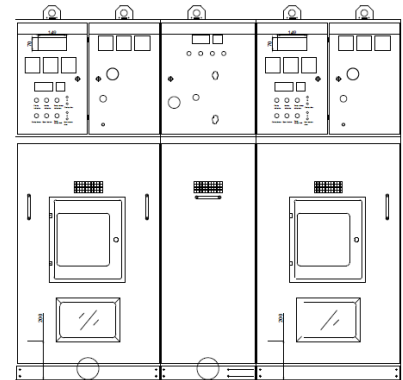

OPTIONAL EQUIPMENTS

EQUIPMENTSSome Optional Equipments that GUCBIR provides with Generator Sets;

- ◆ Different voltage alternator,
- ◆ Remote radiator applications,
- ◆ Automatic fuel filling system,
- ◆ Fuel tank, oil pan, dashboard, alternator, coil heaters,
- ◆ Alternator with double AVR and PMG,
- ◆ Synchronization systems, The generator output breaker,
- ◆ Grid-generator transfer switches,
- ◆ Accordance with the specific volume of demand-insulated cabins,
- ◆ Seismic solutions,
- ◆ Trailer, Fire extinguishing inside containers
- ◆ Remote monitoring
- ◆ SMPS 12/24V 10A

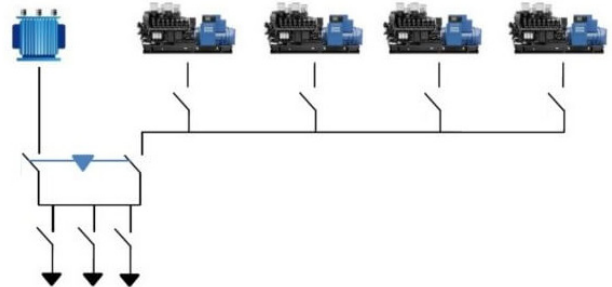

Synchronization systems as needed From 2 generators to 32 generators